

Low Frequency Oscillation Analysis in Parallel AC/DC System by a Novel Dynamic Model

H. R. Najafi, F. Robinson, Member, IEEE, IEE, A. Shoulaie

Abstract— A novel approach is presented for efficiently modeling a power system which includes parallel-connected HVAC, and HVDC transmission systems. The proposed model has been derived for a system in which an AC generator is connected to an infinite bus system through a parallel AC tie line and a HVDC link. In addition to state-space representation, a block diagram representation has been formed to analyze system stability. In this new block diagram representation, the dynamic characteristics of the system are expressed in terms of a newly developed H constant. The development of the block diagram and associated H constants are explained. The new model is evaluated using PSCAD/RTDS real time digital simulation. Based on this new model, the low frequency oscillation phenomenon in parallel AC/DC system is studied and the results are shown.

Index Terms— HVDC transmission control, Power System Dynamic Stability

I. INTRODUCTION

IN recent years, power systems have been required to operate close to their stability limits for extensive periods. The stability of a power system may be improved by incorporating an HVDC power transmission system. The improvement arises from the HVDC link's controllable characteristics which may be used to moderate system stability and thereby overcome some limitations inherent in HVAC transmission systems. It is well known that the transient stability of the AC system in a composite AC-DC system can be improved by taking advantage of the fast controllability of HVDC converters [1-6]. There are, therefore, good reasons for constructing HVDC links in close proximity to HVAC lines. Construction of DC and AC lines on a common structure may even be considered as an option for maximizing right-of-way utilization. This structure significantly affects system design and performance. One sophisticated advantage of such composite systems is the enhanced damping of the AC transmission that is possible using power modulation via the HVDC link [7]-[12]. However, the torsional interaction

between the HVDC link and the turbine generator is a recognized problem that must be addressed [13]. Several studies have been made to identify the cause of interaction and to devise countermeasures for these sub-synchronous oscillations [14-15].

To develop insight into system behavior and to facilitate the design and optimization of the controller, it is of considerable benefit to have an efficient dynamic model of the HVAC-HVDC system. There are many publications in the field of HVDC system modeling which range from simple linear models to more complex nonlinear models. These generally offer the most rigorous and accurate HVDC modeling theory available at the time of publication. The small-signal analysis of HVDC converter systems has received significant attention in the literature [16-18]. An analytical model is presented and utilized for small-signal analysis of HVDC-HVAC interactions in [16]. The analytic modeling provides useful insight and makes possible a good understanding of HVDC system behavior. A small-signal analytic frequency domain model of a 6-pulse HVDC converter based on a piecewise-linear state variable representation of the converter is presented in [17]. In [18], a structured subsystem modeling approach is used for the formation of small-signal dynamic state models of FACTS and HVDC systems. Previous publications have proved that linearized modeling is an effective approach for HVDC converter control analysis and design. The HVDC converter introduces non-linearity and delay into the system, but the non-linearity of the HVDC system can be linearized over a wide range of system operation with $\pm 5\%$ error [19]. In most simulation, detailed representation of the HVDC converter is not necessary. Depending on the objective of a study, the involved converter sub-system can always be reduced to some extent with minimal loss of accuracy.

In this paper a novel approach is presented to model parallel-connected HVAC and HVDC systems. The proposed model is based on a typical AC/DC system in which the AC generator is connected to an infinite bus system through a parallel AC tie line, and an HVDC link. In addition to the state-space representation, a block diagram representation is formed to analyze the system stability characteristics. In this new block diagram representation, the dynamic characteristics of the system are expressed in terms of the newly developed so-called H constants [20-21]. The basis for the block diagram and expression for the associated constants are developed.

The block diagram approach was first used by Heffron and Phillips [22] and later by deMello and Concordia [23] to analyze the small-signal stability of synchronous

H.R. Najafi is with Power Group, Engineering Department, University of Birjand, Birjand, IRAN, (e-mail: H.R.Najafi@birjand.ac.ir)

F. Robinson is with the Department of Electronic & Electrical Engineering, University of Bath, Bath, UK (e-mail: F.V.P.Robinson@bath.ac.uk)

A. Shoulaie is with Power Group, Electrical Engineering Department, Iran University of Science and Technology, Tehran, IRAN (e-mail: Shoulaie@iust.ac.ir)

machines. The new dynamic model has similarities with DeMello and Concordia dynamic model for a single machine connected to a large system through AC transmission lines. While this model is not suitable for a detailed study of large systems, it is useful in gaining a physical insight into the effects of various system dynamics and in establishing the basis for methods of enhancing stability through synchronous machine and HVDC converter controls. By this modeling approach, it is possible to analyze the small-signal stability of the system and low-frequency oscillation phenomena with the synchronous machine represented by models of varying degrees of detail and the HVDC link in different control modes. The following assumptions are made in deriving the proposed model:

- The Shunt filters are neglected because of their high working frequency,
- A π model is selected for the AC tie line and a T model for the DC line,
- The inverter AC bus is connected to an infinite bus,
- A third-order dynamic model is used for the synchronous machine,
- A first-order model is used for the excitation system,
- The effect of the governor and the turbine are neglected because of their relatively slow response.

II. DESCRIPTION OF THE STUDY SYSTEM

The general system configuration is shown in Figure 1. A synchronous generator is connected to a large power system through parallel-connected HVAC and HVDC transmission lines [24-26]. A static three-phase load and a capacitor bank are connected to the machine bus.

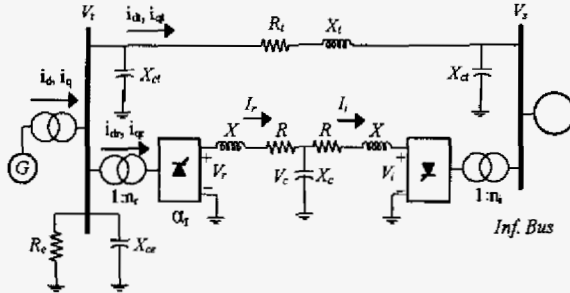

Fig. 1 Single line diagram of the study system

The dynamic behavior of the synchronous generator is described by Park's equations [27] where the frame of reference is synchronized to the rotor. The HVDC line commutated converters are 12-pulse types with conventional constant current control at the rectifier and constant extinction angle control at the inverter. The AC transmission line is represented by an equivalent π circuit, and the DC transmission line is represented by an equivalent T network with a lumped charging capacitance located at the midpoint of the DC link.

III. SYSTEM EQUATIONS

In developing the linearized system equations, it is convenient to neglect the harmonics produced by the switching within the HVDC converters and to choose the three sets of reference axes as shown in Fig. 2 [21-24]. The equations of the synchronous machine are written assuming a rotor reference frame denoted as the q^r - d^r axis. The second and third reference axes (the q^i - d^i axis and q^s - d^s axis) are chosen such that their q -axis coincides with the fundamental voltage phasors of generator and infinite buses respectively.

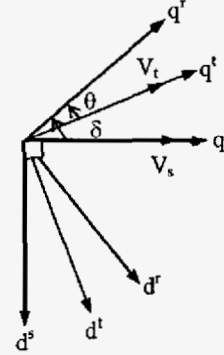

Fig. 2 Relationship between different coordinate axes

A. HVDC Link

The average output voltage and current of the HVDC converters may be expressed in terms of voltage and current in the reference frame of the converter bus [24]. The following equations are obtained through the method set forth in [24] and [25] for DC quantities.

$$V_R = \frac{3\sqrt{3}}{\pi m_R} V_{q^i} \cos \alpha_R - \frac{3}{\pi} X_{co} I_R \quad (1)$$

$$V_I = \frac{3\sqrt{3}}{\pi m_I} V_{q^s} \cos \gamma_I - \frac{3}{\pi} X_{co} I_I \quad (2)$$

$$i_{qR} = \frac{2\sqrt{3}}{\pi m_R} I_R \cos \phi_R, \quad i_{dR} = \frac{2\sqrt{3}}{\pi m_R} I_R \sin \phi_R \quad (3)$$

$$i_{qI} = -\frac{2\sqrt{3}}{\pi m_I} I_I \sin \phi_I, \quad i_{dI} = -\frac{2\sqrt{3}}{\pi m_I} I_I \sin \phi_I \quad (4)$$

where,

$$\cos \phi_R = \frac{\pi m_R}{3\sqrt{3}} \frac{V_R}{V_{q^i}} \quad (5)$$

$$\cos \phi_I = \frac{\pi m_I}{3\sqrt{3}} \frac{V_I}{V_{q^s}} \quad (6)$$

The rectifier currents i_{qR} and i_{dR} are referred to the q^i - d^i reference frame, i_{qI} and i_{dI} are the inverter current referred to the q^s - d^s reference frame. Also, X_{co} is the commutating reactance, α_R is the delay angle of the rectifier, and γ_I is the extinction angle of the inverter.

The DC line model is given by the following equations:

$$V_R = RI_R + \frac{X}{\omega_b} pI_R + V_C \quad (7)$$

$$V_t = V_C - RI_t - \frac{X}{\omega_b} pI_t \quad (8)$$

where,

$$V_C = \frac{\omega_b X}{p} (I_R - I_t) \quad (9)$$

The operator $p = d/dt$ and ω_b is the base electrical angular velocity herein, selected as 314 rad/sec.

The AC current of the rectifier converter where referred to the generator rotor reference frame is given by:

$$\begin{bmatrix} i_{dR}^r \\ i_{qR}^r \end{bmatrix} = \frac{2\sqrt{3}}{\pi m_R} \begin{bmatrix} \cos \theta & -\sin \theta \\ \sin \theta & \cos \theta \end{bmatrix} \begin{bmatrix} \cos \phi_R \\ \sin \phi_R \end{bmatrix} I_R \quad (10)$$

where θ is defined in Fig. 2.

Substituting (8) by deviation, we get:

$$\begin{bmatrix} \Delta i_{dR}^r \\ \Delta i_{qR}^r \end{bmatrix} = \begin{bmatrix} m_1 \\ m_2 \end{bmatrix} \Delta \theta + \begin{bmatrix} m_3 \\ m_4 \end{bmatrix} \Delta \phi_R + \begin{bmatrix} m_5 \\ m_6 \end{bmatrix} \Delta I_R \quad (11)$$

The incremental DC voltage deviation in the rectifier side can be described by (substituting Eq. 1 by deviation):

$$\Delta V_R = m_7 \Delta V_{qt}' - m_8 \Delta \alpha_R - m_9 \Delta I_R \quad (12)$$

If the system reference is chosen such that the quadrature axis is aligned with the rectifier AC bus voltage V_t as in Fig. 2, then $V_{qt}' = V_t$ and $V_{dt}' = 0$.

By defining, $V_t = V_{qt}' = \sqrt{(V_d^r)^2 + (V_q^r)^2}$ and $V_q^r = V_t \cos \theta$, the following equations can be derived.

$$\Delta V_t = m_{10} \Delta V_q^r + m_{11} \Delta V_d^r \quad (13)$$

$$\Delta \theta = m_{12} \Delta V_q^r + m_{13} \Delta V_d^r \quad (14)$$

From Eq. 5 and Eq. 12, we can conclude:

$$\Delta \phi_R = m_{14} \Delta V_q^r + m_{15} \Delta V_d^r + m_{16} \Delta \alpha_R + m_{17} \Delta I_R \quad (15)$$

The quantities $m_i (i=1, \dots, 17)$ are described in Appendix.

Finally, the incremental DC current deviations using a rotor reference frame are obtained as follows:

$$\begin{bmatrix} \Delta i_{dR}^r \\ \Delta i_{qR}^r \end{bmatrix} = \begin{bmatrix} D_1 & D_2 \\ D_3 & D_4 \end{bmatrix} \begin{bmatrix} \Delta V_d^r \\ \Delta V_q^r \end{bmatrix} + \begin{bmatrix} T_d \\ T_q \end{bmatrix} \Delta \alpha_R + \begin{bmatrix} Z_d \\ Z_q \end{bmatrix} \Delta I_R \quad (16)$$

The quantities $D_i (i=1, \dots, 4)$, T_j and $Z_j (j=d, q)$ are described in Appendix.

B. Synchronous generator and AC Transmission Line

The Park d - q axis model of the synchronous machine is well established [27]. For this model, the number of rotor circuits represented may be varied according to the required degree of compatibility with the actual machine and the time scale of system phenomena. In all these variant models, the stator-winding transients are neglected such that the stator voltage equations are only algebraic. These equations are well known and not included. The excitation system equation is derived directly from Fig. 3. This figure shows a simple exciter model that can also be regarded as a reduced model of a fast static exciter with no transient gain reduction as used in [21].

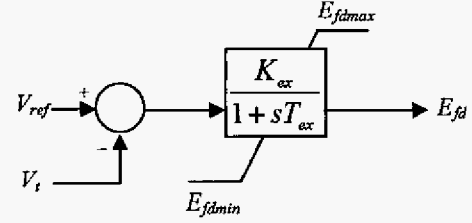

Fig. 3 Simple exciter model

For some simplicity, the following quantities are defined:

$$Z = R_t + jX_t, \quad Y = \frac{1}{R_s} + j\left(\frac{1}{X_{ce}} + \frac{1}{X_{ci}}\right),$$

$$C_1 + jC_2 = 1 + ZY, \quad I = I_d + jI_q$$

By using the above quantities, the following equation can be derived for rectifier AC bus:

$$ZI = (1 + ZY)V_t - V_s + Z(I_{dr} + jI_{qr}) \quad (17)$$

If the resistance of stator winding is assumed zero, we can write the following matrix equation for stator winding current and voltage:

$$\begin{bmatrix} \Delta V_d \\ \Delta V_q \end{bmatrix} = \begin{bmatrix} 0 \\ 1 \end{bmatrix} \Delta E_q' - \begin{bmatrix} 0 & -X_q' \\ X_d' & 0 \end{bmatrix} \begin{bmatrix} \Delta I_d \\ \Delta I_q \end{bmatrix} \quad (18)$$

After some calculations and using the above equations, we get [20]:

$$\begin{bmatrix} \Delta I_d \\ \Delta I_q \end{bmatrix} = \begin{bmatrix} Y_d \\ Y_q \end{bmatrix} \Delta E_q' + \begin{bmatrix} F_d \\ F_q \end{bmatrix} \Delta \delta + \begin{bmatrix} T_d' \\ T_q' \end{bmatrix} \Delta \alpha_R + \begin{bmatrix} Z_d' \\ Z_q' \end{bmatrix} \Delta I_R \quad (19)$$

The expressions for $Y_d, Y_q, F_d, F_q, T_d', T_q', Z_d'$ and Z_q' are given in the Appendix.

IV. BLOCK DIAGRAM REPRESENTATION

The small-signal dynamics of the parallel HVAC and HVDC systems are represented by the block diagram in Fig. 4. In this representation, the dynamic characteristics of the system are expressed in term of the so-called H constants [21, 22]. The block diagram and the equations for the associated constants are developed here. It should be noted that ΔU_{sup1} and ΔU_{sup2} are supplementary control signals.

A. Electrical Torque Equation (H_1 - H_4)

Electrical torque of a synchronous machine at nearby synchronous speed is approximated by:

$$T_e \cong P_e = I_d V_d + I_q V_q \quad (20)$$

By substituting Eq.20 by deviation, and using Eq.18, the change in electrical torque may be expressed as a function of $\Delta \delta$, $\Delta E_q'$, $\Delta \alpha_R$ and ΔI_R as follows:

$$\Delta T_e = H_1 \Delta \delta + H_2 \Delta E_q' + H_3 \Delta \alpha_R + H_4 \Delta I_R \quad (21)$$

The expression for $H_1 \sim H_4$ are given by Eq.22.

$$\begin{bmatrix} H_1 \\ H_2 \\ H_3 \\ H_4 \end{bmatrix} = \begin{bmatrix} 0 \\ I_{q0} \\ 0 \\ 0 \end{bmatrix} + \begin{bmatrix} F_d & F_q \\ Y_d & Y_q \\ T_d' & T_q' \\ Z_d' & Z_q' \end{bmatrix} \begin{bmatrix} (X_q - X_d') I_{q0} \\ E_{q0}' + (X_q - X_d') I_{q0} \end{bmatrix} \quad (22)$$

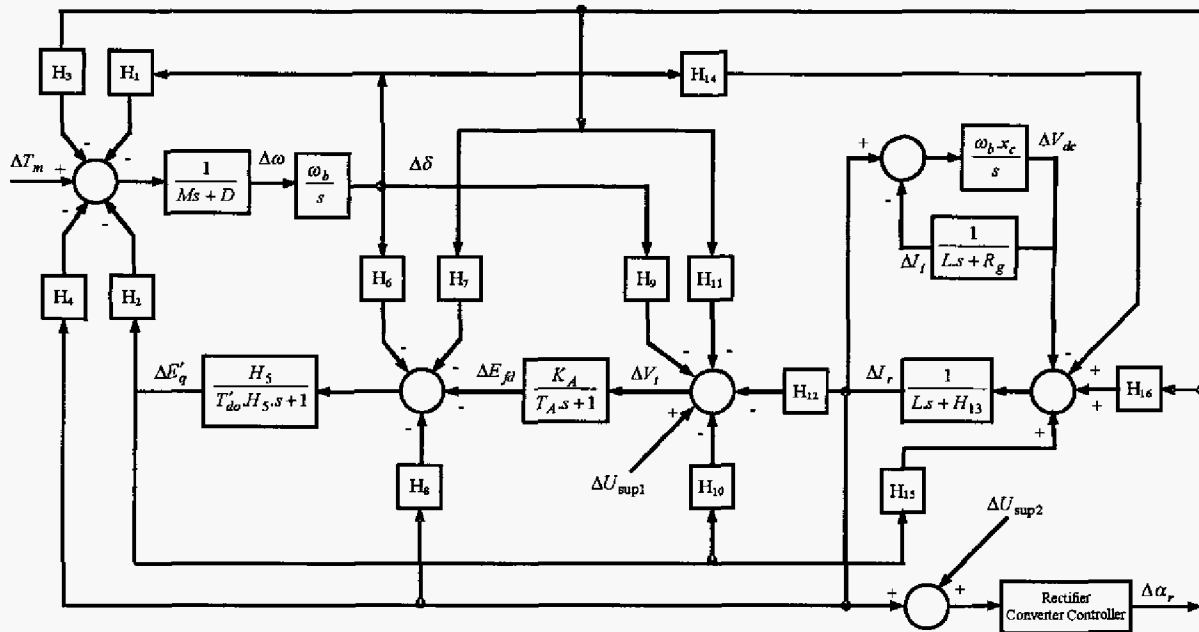

Fig. 4 The block diagram representation of parallel HVAC/HVDC system.

B. Rectifier AC Bus Voltage Equation ($H_9 \sim H_{12}$)

Linear equation of exciting winding voltage, by attention to the generator dynamic third-order model is:

$$\Delta E'_q = \frac{H_5}{1+sT'_{do}H_5} [\Delta E_{fl} - H_6\Delta\delta - H_7\Delta\alpha_R - H_8\Delta I_R] \quad (23)$$

The expression for $H_5 \sim H_8$ are given by:

$$H_5 = \frac{1}{1+(X_d - X'_d)Y_d}, \begin{bmatrix} H_6 \\ H_7 \\ H_8 \end{bmatrix} = (X_d - X'_d) \begin{bmatrix} F_d \\ T'_d \\ Z'_d \end{bmatrix} \quad (24)$$

C. Excitation Voltage Equation ($H_9 \sim H_{12}$)

Now, by using Eq.18 and Eq.19, we may express the change in generator terminal AC voltage as a function of $\Delta\delta$, $\Delta E'_q$, $\Delta\alpha_R$ and ΔI_R as follows:

$$\Delta V_t = H_9\Delta\delta + H_{10}\Delta E'_q + H_{11}\Delta\alpha_R + H_{12}\Delta I_R \quad (25)$$

The expression for $H_9 \sim H_{12}$ are given by Eq.26.

$$\begin{bmatrix} H_9 \\ H_{10} \\ H_{11} \\ H_{12} \end{bmatrix} = \begin{bmatrix} 0 \\ V_{q0}/V_{t0} \\ 0 \\ 0 \end{bmatrix} + \begin{bmatrix} F_d & F_q \\ Y_d & Y_q \\ T'_d & T'_q \\ Z'_d & Z'_q \end{bmatrix} \begin{bmatrix} -X'_d \frac{V_{q0}}{V_{t0}} \\ X_q \frac{V_{d0}}{V_{t0}} \end{bmatrix} \quad (26)$$

D. Rectifier DC Current Equation ($H_{13} \sim H_{16}$)

By substituting Eq.4 into Eq.7, and after some calculation and deviation we get:

$$\Delta I_R = \frac{1}{sL + H_{13}} [H_{14}\Delta\delta + H_{15}\Delta E'_q + H_{16}\Delta\alpha_R - \Delta V_c] \quad (27)$$

The expression for $H_{13} \sim H_{16}$ are given by Eq.28 and Eq.29.

$$H_{13} = R + \frac{3}{\pi} X_{co} - 3K_r H_{12} \cos \alpha_{R0} \quad (28)$$

$$\begin{bmatrix} H_{14} \\ H_{15} \\ H_{16} \end{bmatrix} = \begin{bmatrix} 0 \\ 0 \\ -3K_r V_{t0} \sin \alpha_{R0} \end{bmatrix} + 3K_r \cos \alpha_{R0} \begin{bmatrix} H_9 \\ H_{10} \\ H_{11} \end{bmatrix} \quad (29)$$

V. VALIDATION AND APPLICATION

The accuracy of the proposed model was investigated by comparing the disturbance response with that obtained from PSCAD/RTDS Real Time Digital Simulation [21].

Fig. 5 and Fig. 6 show the comparison of the generator rotor angle swing response and generator speed swing response to a 1% increase in generator mechanical torque, respectively. The proposed model outputs are illustrated in Fig. 7 and Fig. 8.

The agreement between the proposed model and PSCAD/RTDS response is good and confirms that the proposed model and its block diagram representation can be used in small signal analysis, controller and power system stabilizer design.

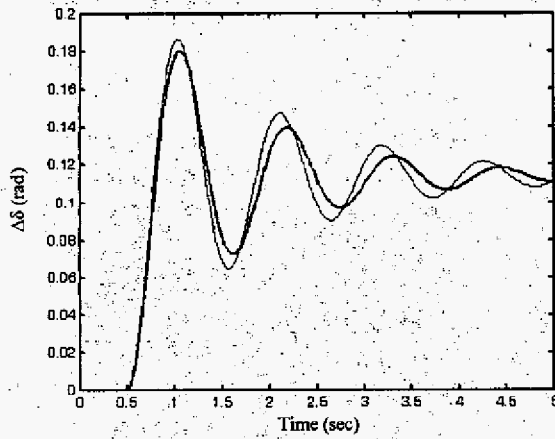

Fig. 5 Generator rotor angle swing after a step change in input torque (—) proposed model, (---) RTDS

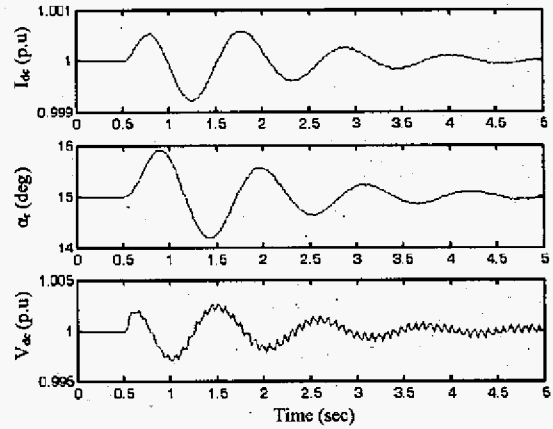

Fig. 8 Proposed model outputs (DC quantities) after a step change in input torque

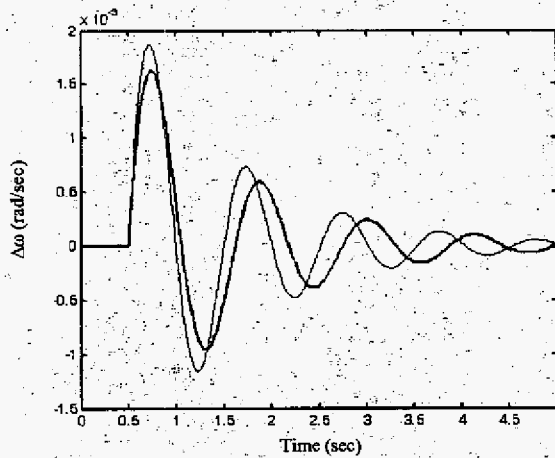

Fig. 6 Generator speed swing after a step change in input torque (—) proposed model, (---) RTDS

To illustrate this, finally by adding power modulation signal to the rectifier controller of the HVDC link (ΔU_{sup2}), simulation is repeated. Fig. 9 compares the generator speed swing with and without using HVDC system power modulation. The results show a great improvement in the dynamic response of system.

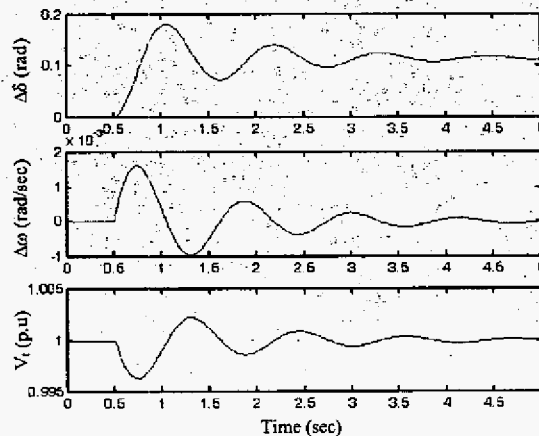

Fig. 7 Proposed model outputs (AC quantities) after a step change in input torque

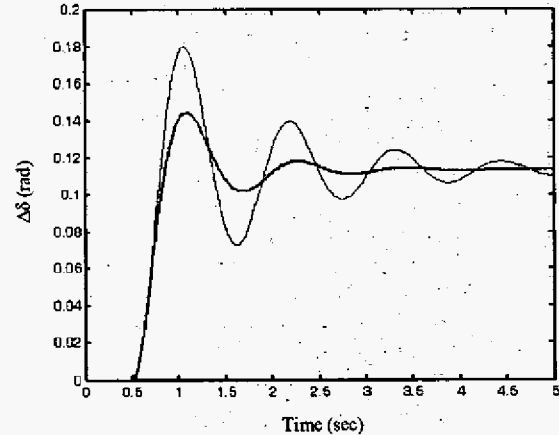

Fig. 9 Generator rotor angle swing after a step change in input torque (—) without and (---) with supplementary control signal (ΔU_{sup2})

VI. CONCLUSION

A new block diagram representation has been developed for small-signal analysis of a parallel HVAC/HVDC system. In this block diagram representation, the dynamic characteristics of the system are expressed in terms of the newly developed so-called H constants. Application of the proposed model in power oscillation analysis and comparison of the results with time domain simulation has shown that this technique is sufficiently accurate and of benefit for the small-signal analysis of parallel connected HVAC and HVDC systems.

VII. APPENDIX

$$\begin{aligned} \begin{bmatrix} m_1 \\ m_2 \end{bmatrix} &= \frac{2\sqrt{3}I_{R0}}{\pi R} \begin{bmatrix} -\sqrt{2} \sin \theta_0 \cos(\varphi_0 - 45^\circ) \\ \cos(\theta_0 + \varphi_{R0}) \end{bmatrix}, \\ \begin{bmatrix} m_3 \\ m_4 \end{bmatrix} &= \frac{2\sqrt{3}I_{R0}}{\pi R} \begin{bmatrix} \sin(\varphi_0 - \theta_0) \\ \cos(\varphi_0 + \theta_0) \end{bmatrix}, \\ \begin{bmatrix} m_5 \\ m_6 \end{bmatrix} &= \frac{2\sqrt{3}}{\pi R} \begin{bmatrix} \cos(\varphi_0 + \theta_0) \\ \sin(\varphi_0 + \theta_0) \end{bmatrix}, \quad m_7 = \frac{3\sqrt{3}}{\pi R} \cos \alpha_{R0}, \\ m_8 &= V_{r0} \sin \alpha_{R0}, \quad m_9 = \frac{3}{\pi} X_{co}, \quad m_{10} = \frac{V'_{q0}}{V_{r0}}, \\ m_{11} &= \frac{V'_{d0}}{V_{r0}}, \quad m_{12} = \frac{V'_{q0} \cos \theta_0 - V_{r0}}{V_{r0}^2 \sin \theta_0}, \quad m_{13} = \frac{V'_{d0} \cos \theta_0}{V_{r0}^2 \sin \theta_0}, \\ m_{14} &= \frac{V'_{q0} (\cos \varphi_{R0} - \cos \alpha_{R0})}{V_{r0}^2 \sin \varphi_{R0}}, \quad m_{16} = \frac{\sin \alpha_{R0}}{\sin \varphi_{R0}}, \\ m_{15} &= \frac{V'_{d0} (\cos \varphi_{R0} - \cos \alpha_{R0})}{V_{r0}^2 \sin \varphi_{R0}}, \quad m_{17} = \frac{n_R X_{co}}{\sqrt{3} V_{r0} \sin \varphi_{R0}}, \\ \begin{bmatrix} D_1 & D_2 \\ D_3 & D_4 \end{bmatrix} &= \begin{bmatrix} \cos(\theta_0 + \varphi_{R0}) \\ -\sin(\theta_0 + \varphi_{R0}) \end{bmatrix} \begin{bmatrix} m_{12} + m_{14} & m_{13} + m_{15} \end{bmatrix}, \\ \begin{bmatrix} T_d \\ T_q \end{bmatrix} &= \frac{2\sqrt{3}I_{R0} \sin \alpha_{R0}}{\cos \varphi_{R0}} \begin{bmatrix} \cos(\theta_0 + \varphi_{R0}) \\ -\sin(\theta_0 + \varphi_{R0}) \end{bmatrix}, \\ \begin{bmatrix} Z_d \\ Z_q \end{bmatrix} &= \begin{bmatrix} \sin(\theta_0 + \varphi_{R0}) \\ \cos(\theta_0 + \varphi_{R0}) \end{bmatrix} + \frac{2\sqrt{3}n_R I_{R0} X_{co}}{\sqrt{3} V_{r0} \sin \varphi_{R0}} \begin{bmatrix} \cos(\theta_0 + \varphi_{R0}) \\ -\sin(\theta_0 + \varphi_{R0}) \end{bmatrix}, \\ \begin{bmatrix} Y_d \\ Y_q \end{bmatrix} &= \frac{1}{Z_e^2} \begin{bmatrix} R_1 & X_1 \\ X_2 & R_2 \end{bmatrix} \begin{bmatrix} F_d \\ F_q \end{bmatrix} = \frac{V_{r0}}{Z_e^2} \begin{bmatrix} -R_1 & X_1 \\ X_2 & R_2 \end{bmatrix} \begin{bmatrix} \cos \delta_0 \\ \sin \delta_0 \end{bmatrix}, \\ \begin{bmatrix} T'_d \\ T'_q \end{bmatrix} &= \frac{1}{Z_e^2} \begin{bmatrix} R_1 & X_1 \\ X_2 & R_2 \end{bmatrix}, \\ \begin{bmatrix} Z'_d \\ Z'_q \end{bmatrix} &= \frac{1}{Z_e^2} \begin{bmatrix} R_1 & X_1 \\ -X_2 & R_2 \end{bmatrix} \begin{bmatrix} R_t Z_d - X_t Z_q \\ X_t Z_d + R_t Z_q \end{bmatrix}, \\ S_{11} &= R_t D_2 - X_t D_4 - C_2, \quad S_{12} = R_t D_1 - X_t D_3 + C_1 \\ S_{21} &= X_t D_2 + R_t D_4 + C_1, \quad S_{22} = X_t D_1 - R_t D_3 + C_2 \\ R_1 &= R_t - X_q S_{22} \quad R_2 = R_t + X'_d S_{11}, \quad X_1 = X_t + X_q S_{12} \\ X_2 &= X_t + X'_d S_{21}, \quad Z_e^2 = R_t^2 + X_t^2 + X_d X'_d (S_{12} S_{21} - S_{11} S_{22}) \end{aligned}$$

VIII. REFERENCES

- [1] K.R. Padiyar, "HVDC Power Transmission Systems, Technology and System Interactions", John Wiley and Sons, 1990. F. Fuller, E. F. Fuchs, and K. J. Roessler, "Influence of harmonics on power distribution system protection," *IEEE Trans. Power Delivery*, vol. 3, pp. 549-557, Apr. 1988.
- [2] A. Hammad, C. Taylor, "HVDC Controllers for System Dynamic Performance", *IEEE Trans. on Power System*, Vol.6, No.2, pp. 743-752, May 1991.
- [3] J.O. Gjerde, R. Flolo, T. Gjengedal, "Use of HVDC and FACTS components for enhancement of power system stability", 8th Mediterranean Electro technical Conf., MELECON 96, vol.2, pp.802-808, May 1996.
- [4] G.M. Huang, V. Krishnaswamy, "HVDC Controls for Power System Stability", *IEEE Power Eng. Society Summer Meeting*, vol.1, pp.597-602, July 2002.
- [5] M. Baker, K. Abbott, B. Gemmill, "Frequency and system damping assistance from HVDC and FACTS controller", *Power Engineering Society Summer Meeting*, 2002 IEEE, vol.2, pp. 770-773, July 2002.
- [6] S. Corsi, A. Danelli, M. Pozzi, "Emergency stability controls through HVDC links", *IEEE Power Eng. Society Summer Meeting*, Vol.2, pp.774-779, July 2002.
- [7] R.L. Cresap, D.N. Scott, W.A. Mittelstadt, "Small signal modulation of Pacific HVDC inter-tie", *IEEE on Power Apparatus and Systems*, PAS-95, No.2, pp. 536-541, March/April 1976.
- [8] R. L. Cresap, D. N. Scott, W. A. Mittelstadt, C. W. Taylor, "Operating experience with modulation of Pacific HVDC Inter-tie", *IEEE Trans. on Power Apparatus and Systems*, vol. PAS-97, no.4, pp. 1053-1059, July/August 1978.
- [9] C. Grund, J. Reeve, "Increased performance of HVDC power modulation by active and reactive power coordination and modern control", *IEEE AC & DC Transmission*, London, 1981.
- [10] L. Bergqvist, et al., "Design of a modulation controller for stabilization of parallel AC lines in the Rihand-Delhi HVDC transmission," *CIGRE Symp. On AC/DC Trans. Interactions*, pp. 300-14, Sep. 1987.
- [11] C. Taylor, J. Hauer, "Supplementary HVDC control in a power system with parallel AC & DC transmission," *CIGRE col.*, on HVDC power transmission, Recife, paper I-06, 1989.
- [12] I. Ngarmoo, "A stabilization of frequency oscillation using a power modulation control of HVDC link in a parallel AC-DC interconnected system", *Proc. of the Power Conversion Conference, PCC Osaka 2002*, Vol.3, pp.1405-1410, April 2002.
- [13] M.Bahman, et al., "Experience with HVDC-turbine-generator torsional interaction at Square Butte", *IEEE Trans. PAS-99*, pp. 966-975, 1980.
- [14] S.O. Faried, A.M. El-Serafi, "Effect of HVDC converter station faults on turbine-generator shaft torsional torques", *IEEE Transactions on Power Systems*, vol. 12 Issue: 2, pp. 875 -881 May 1997.
- [15] T.J. Hammons, J.J. Bremner, "Stressing of turbine-generator-exciter shafts by variable-frequency currents superimposed on DC currents in asynchronous HVDC links and following disturbances at converter stations", *IEEE Trans. on Energy Conversion*, Vol.9, pp. 503-513, Sept. 1994.
- [16] D. Jovic, N. Pahalawaththa, M. Zavaahir, "Analytical modeling of HVDC-HVAC systems", *IEEE Trans. on Power Delivery*, vol.14, pp. 506-511, April 1999.
- [17] C.M. Osaukas, et al., "Small-signal frequency domain model of an HVDC converter", *IEE, Proc. -Gener.-Transm.-Distrib.* Vol-148, no.6, Nov. 2001.
- [18] C. Osaukas, A. Wood, "Small-Signal dynamic modeling of HVDC systems", *IEEE Trans. on Power Delivery*, vol.18, no.1, Jan. 2003.
- [19] P.K. Kalra, "An approach for handling the non-linearities of HVDC system for stability analysis", *IEEE Trans. on Power electronics*, vol.5, no.3, pp. 371-377, July 1990.
- [20] A. Hemati, "Investigation of Dynamic effects of HVDC systems", M.S. Thesis, IUST, Iran, 1994.
- [21] H.R. Najafi, "A New Protection-Control Scheme for Stabilization of HVDC systems," PhD Thesis, IUST, Iran, 2004.
- [22] W.G. Heffron, R.A. Phillips, "Effect of a modern voltage regulator on under-excited operation of large turbine generators," *AIEE Trans.* 71:692-697, 1952.
- [23] F.P. DeMello, C. Concordia, "Concepts of Synchronous machine stability as affected by excitation control," *IEEE Trans. PAS-88*, pp. 316-329, 1969.
- [24] H.A. Peterson, P.C. Krause, "A direct and quadrature-axis representation of a parallel AC and DC power system," *IEEE Trans. Power Apparatus and Systems*, vol. PAS 85, pp.210-255, March 1966.
- [25] J.W. Klein, et al., "Dynamic Stability Assessment model of a parallel AC/DC power system," *IEEE Trans. Power Apparatus and Systems*, vol. PAS 96, no. 4, pp.1296-1301, July/August 1977.
- [26] Y.Y. Hsu, L. Wang, "Damping of a parallel AC-DC Power system using PID power system stabilizers and rectifier current regulators," *IEEE Trans. on Energy Conversion*, vol. 3, no. 3, Sep. 1988.
- [27] R.H. Park, "Two-Reaction Theory of Synchronous Machines", *AIEE Trans.* Part 1, Vol. 48, pp.716-730, July 1929, Part 2, vol. 52, pp.352-355, June 1933.